

BARISTA

0-Series

Introducing the **Barista** family of brewing equipment from **Newco Enterprises**. The **Barista** opens up a new world of flavor profile control by providing complete control of the vital brewing parameters: Preinfusion, pulse brewing, water contact time, water temperature and water volume. Two independent brew buttons allow for two different brew volumes and/or two varying strengths from the same machine. All functions are easily programmable from the front of the brewer (no tools necessary).

The Barista has been certified by the SCAM to meet its strict brewing criteria for a Gold Cup standard of coffee.

Barista Technology, only from Newco.



Count Down Timer

*B180-0

dispenser not included

Dispenser Options



3650 NewTown Boulevard • St. Charles, MO 63301

Toll Free 800.325.7867 • Local 636.925.1202 • Fax 636.925.0029 • Technical Service 800.556.3926
www.newcocooffee.com

Cafe Barista

0-Series Features

"Brew 1" and **"Brew 2"** selectors provide a choice of two adjustable flavor profiles or portion sizes.

Water Volume: May be adjusted thru the digital display: thirty ounces to one gallon.

Digital Display: Counts down the minutes and seconds remaining until the basket has finished draining. Visa-Brew time may be adjusted.

Water Temperature: May be adjusted between 170 and 210 degrees from the front touch pad.

Pre-infusion: Wets the coffee grounds to de-gas fresh roasted coffee in the basket so that the grounds may be evenly saturated during the brew cycle.

Pulse Brewing: Pulsed your chosen water temperature onto the coffee bed for ultimate taste profile accuracy.

Water Filtering Light: Offers service operators an opportunity to communicate added value to customers by indicating that fresh water is being drawn into the tank through the filtration system.

Filter Monitor: Alerts the customer when it is time to change the water filter

Audible Signal: Alerts user when the filter basket has finished draining. Your fresh hot coffee is ready!

Coffee Monitor Light: Indicates the freshness of the last beverage brewed.

Cycle Counter: Monitors the number of brew cycles.

Power Conservation: Allows energy saving during idle time.

Service Light: Indicates the appropriate time for scheduled maintenance and accompanies five "Error" messages when operation is interrupted by a fault.

Barista 0

*B180-0 B350-0 Dimensions

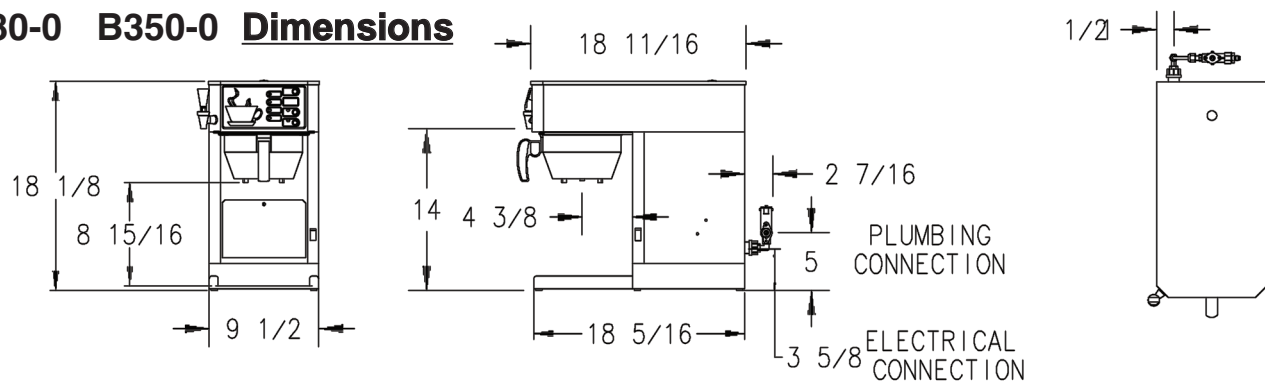

Base Model	Control Option	Part Number	Volts	Amps	Tank* Wattage	Cubic Feet	Ship Weight	Cord Attached
*B-180-0	Barista	* B-180-0	120	15	1800	7.3	32	Yes
B-350-0	Barista	B-350-0	240	14.58	3500	7.3	32	Yes

* Indicates that brewer is for food service only.

Electrical: 120V models are 2 wires plus ground service rated 120V, single phase, 60Hz. 120/240 V models are 3 wires plus ground service rated 120/240 V, single phase, 60Hz

Plumbing: Water line should be 20-90 PSI and have a minimum flow rate of 1.5 GPM. Mechanical connection on brewer is 1/4" male flare connector.